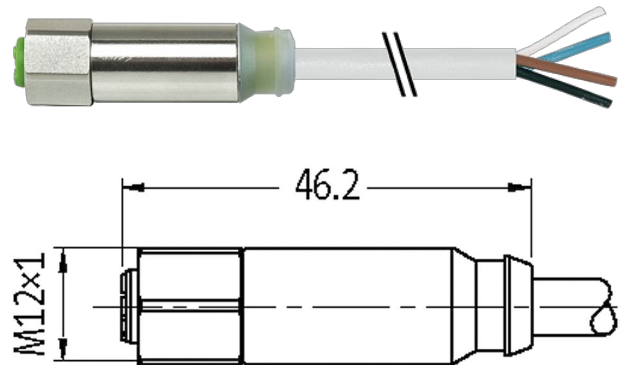

M12 STEEL FEMALE 0° LED

TPE-S-OB 4X0.34 GRAY, 10m

F&B-Steel
 Female straight
 M12, 4-pole
 1 × LED (PNP)
 Further cable lengths on request.

[Link to Product](#)**Illustration**

Product may differ from Image

Approvals

cCSAus



* only for products with UL/CSA approved cable

Form

Form 12292

General data

Pollution Degree 3
 Temperature range -40...+85 °C, depending on cable quality

Cables

No./diameter of wires	4 × 0.34 mm ²
Wire isolation	TPE-S (br, wh, bl, bk)
Material (jacket)	TPE-S
Outer Ø	5.2 mm ±5%
Temperature range (mobile)	-30...+105 °C
Bend radius (moving)	15 × outer Ø
Temperature range (fixed)	-50...+125 °C
Cable identification	336
Cable weight [g/m]	43,01
Material (wire)	Cu wire, bare
Resistor (core)	max. 57 Ω/km (20 °C)
Single wire Ø (core)	0.05 mm
Construction (core)	180 × 0.05 mm (multi-strand wire class 6)

Diameter (core)	4 × 0.34 mm ²
AWG	similar to AWG 22
Material (wire isolation)	TPE-S
Shore hardness (wire isolation)	90 ±5 A
Wire-Ø incl. isolation	1.5 mm ±5%
Color/numbering of wires	br, bk, bl, wh
Stranding combination	4 wires twisted
Shield	no
Material (jacket)	TPE-S
Shore hardness (jacket)	80 ±5 A
Outer-Ø (jacket)	5.2 mm ±5%
Color (jacket)	gray
Test voltage	2500 V AC
Temperature range (fixed)	-50...+125 °C
Temperature range (mobile)	-30...+105 °C
Bend radius (fixed)	10× outer Ø
Bend radius (moving)	15× outer Ø
Jacket Color	gray

Technical Data

Operating voltage	24 V DC ±25%
Rated surge voltage	0.8 kV
Operating current per contact	max. 4 A
Material group	IEC 60664-1, category I
Coding	A-coded
LED display	yellow
Locking of ports	Screw thread (M12×1 mm) recommended torque 0.6 Nm, self-securing
Compression gland	M12 (SW13)
Protection	IP68, IP69K inserted and tightened (EN 60529)
Locking material	Stainless steel 1.4404 (V4A)
suitable for corrugated tube (internal Ø)	without

Commercial data

country of origin	CZ
customs tariff number	85444290
EAN	4048879315821
eClass	27279218
Packaging unit	1

Sketch

Female

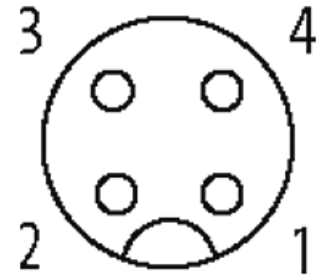

Product may differ from Image